

VAKUMER

VAKUMLA MERMER KALDIRMA

VACUUM LIFTING SYSTEMS FOR MARBLE/GRANITE/TRAVERTINE/ALL NATURAL STONES

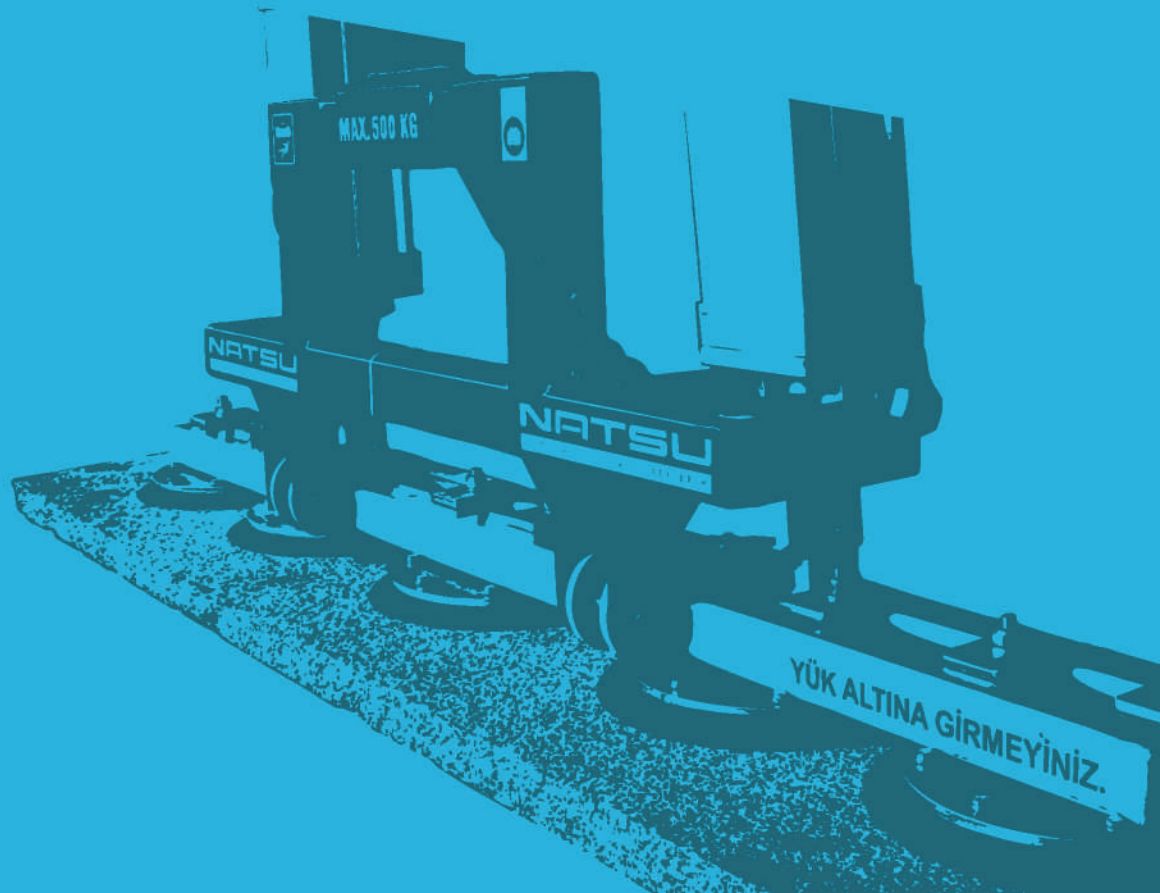

VAKUMER 250-500

BLOK KESME MAKİNASINDAN MANUEL STRİP BOŞALTIMA

Blok kesme makinasında kesilen mermer, granit ve traverten striplerin vakumla alınarak baş kesme, yarma veya palete dizilmesi işlemini yapar. Vakum sistemi, vakum pompalı veya vakum ejektörlü olup, döndürme sistemi pnömatiktir. Pergel vinçte çalışır. Vakum emiş vantuzları optimum değerlerde ürünün boyut ve yapısına göre seçilir. Kırık ve çatlak taşların bile vakumlanarak alınmasına imkan verir. Çevirme sistemi pnömatik olup standart aksesuarlara dahildir.



AVANTAJLARI

- Verimli Çalışma: Çok kısa sürede vakumlanıp alınabilmesinden dolayı blok kesme makinasının daha verimli çalışması
- İşçilik: Taşın alınmasından 2. eleman ihtiyacı duyulmamasından dolayı işçilik avantajı
- Kullanım Kolaylığı: Blok kesme makinasında istediğiniz elemanı çalıştırma rahatlığı
- %100 İş Güvenliği: Sakat taşın kırılması sonucu meydana gelebilecek kaza riskinin 0'a indirilmesi
- Maksimum Hız: ESTE'nin maksimum hızda çalıştırılabilmesi
- Kırılmada Azalma: Taş kırılmalarında azalma
- Dizayn: Çalışılan taşta göre fonksiyonel dizayn



VAKUMER 250-500 MANUEL UNLOADING MACHINE FOR BLOCK CUTTERS

Designed for handling and transporting materials such as marble, granite and travertine slabs. The system works with vacuum pump or ejection. The turning system is pneumatic. Can be mounted on Jib Crane and has a wide range of suction feet selection. Available suction feet for the lifting surface and porosity of the load.



ADVANTAGE

- *Productivity: Vakumer250 allows your operators to productively and effortlessly any object in the workplace*
- *Safety: Vakumer250 minimizes the risk for injury or damage*
- *Maximum Cutting Speed*
- *Functional design due to the material*

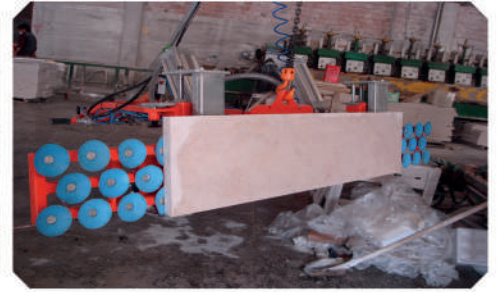

VAKUMER 500-700

BÜYÜK EBATLI MERMER PLAKA TAŞIMA MAKİNALARI

Vakumer mermer sektöründe büyük mermer, granit ve traverten plakaların veya striplerin vakumla kaldırılması, döndürülmesi ve taşınmasında kullanılır. Vakum sistemi vakum pompası veya vakum ejektörü olabilir. Pergel vinç veya gezer vinçte çalışır. Çevirme sistemi pnömatik, hidrolik veya mekanik olabilmektedir. Tüm kullanım donanımları ergonomik olarak yerleştirilmiştir.

- Optimum değerlerde ve ürün cinsine göre vakum emiş vantuzları
- Emniyet mesafesinde kullanma kolu
- Dayanıklı tahrik grupları Malzemenin zarar verilmeden (çizme, kırma) tutulması.
- Görünür yerde vakum kontrolü
- Yükseklik kompasatörlü vakum emiş vantuzları

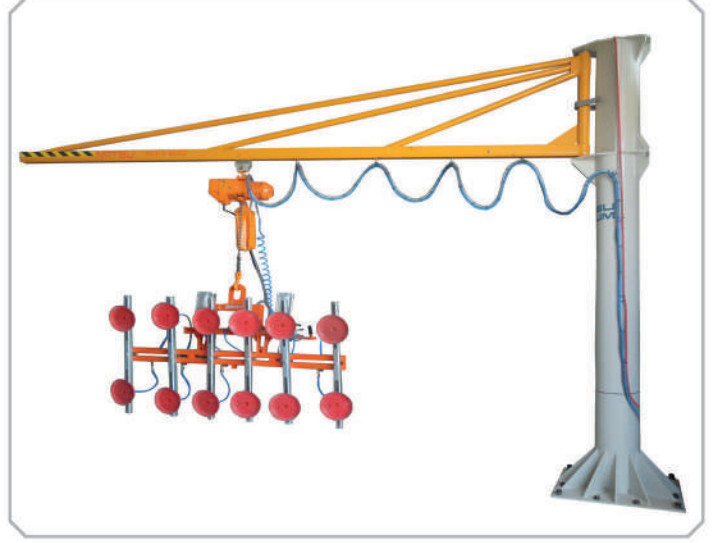

Vakumer is manufactured for lifting big pieces of marble, granite and travertine plates or strips with vacuum technology. The system works with vacuum pump or ejection. Vakumer 500 Can be mounted on a Jib Crane or X-Y bridge Crane. The turning system is optional such as pneumatic, hydraulic or mechanic.

- Easy to operate due to the ergonomic design
- Vacuum pads (suction feet) for handling different materials
- Safety and productivity
- The ideal method for holding and lifting without damage to work piece
- Apparent vacuum control
- Suction feet with height compensator

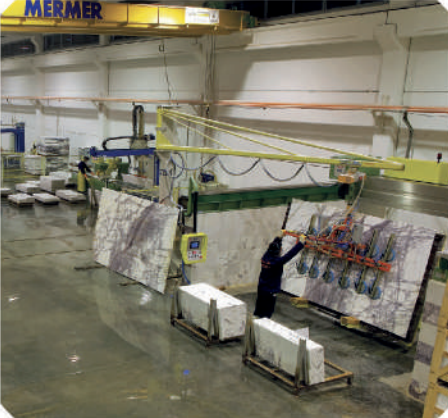

VAKUMER TAK-ÇALIŞTIR

VMP-A / VMP-H

Ağır yükler için AC, DC Veya havayla çalışan kanca altı vakumlu kaldırıcılar büyük levha şeklindeki malzemeleri (mermer, granit, sac, pvc, ctp ...vb) vakumla kaldırmak ve taşınak için tasarlanmıştır. Gezer vinçlere, forklift çatallarına veya pergel vinç kancalarına bağlanarak kullanılan TAK-ÇALIŞTIR kanca altı vakum aparatları dik taşıma yapabilmemin yanında opsiyonel olarak 90 derece yatırma, 90 derece çevirme (döndürme) veya 180 derece çevirme yapabilmektedir. Bu ilave hareketler manuel seçeneği olabildiği gibi lineer aktüatörlü veya hidrolik olabilmektedir.



Kanca altı kancaların en önemli katkılarından birisi kullanıcıyı aşırı derecede zorlamadan malzemeleri kaldırma ve idare etme becerileridir. Malzemeleri dik ya da yatay konumda basitçe bir yerden başka bir yere taşımak, tek bir düğmeye basarak eğilme ve dönme hareketini gerçekleştirmek bu na örnek olarak verilebilir. İşin gereksinimi ne olursa olsun, kanca altı vakumlu kaldırıcılar malzemeleri hızlı ve zahmetsiz bir şekilde taşımaları sağlar.



Heavy loads for AC, DC or air-powered vacuum lifters a large sheet of hook-shaped material (marble, granite, sheetmetal, PVC, FRP, etc.) they are designed to lift and carry the vacuum. Overhead cranes, forklift fork hook or jib of the crane is used by connecting to the plug-and-play. Able to move the next hook 90 degree upright vacuum deposit apparatus, optional, 90 degree rotation (no rotation) or 180 degrees flip. These additional options such as manual or hydraulic actuated gate may be linear movements. One of the most important contributions of the user hooks the hook removal of materials from excessive force and coping skills. Simply to move materials from one place to another in upright or horizontal position, by bending and pressing a single button to perform the rotational movement can be given as an example. Regardless of the work requirements. Hook vacuum lifters allows materials to move in a quick and effortless manner.

VAKUMLU MERMER-GRANİT-TRAVERTEN KALDIRMA

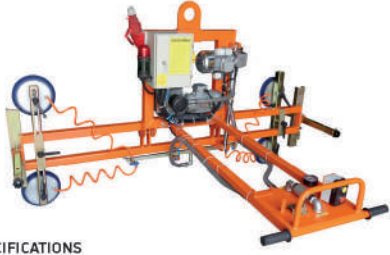

TECHNICAL SPECIFICATIONS

MODEL	VMP-A 250 / 4
LIFTING CAPACITY	250 KG
SYSTEM	VACUUM PUMP
TILTING	LINEER ACTUATOR
SYSTEM REQUIREMENT	ELECTRIC
MAX.WORKPIECE DIMENSIONS	2000 X 3000
MIN.WORKPIECE DIMENSIONS	600 X 1850

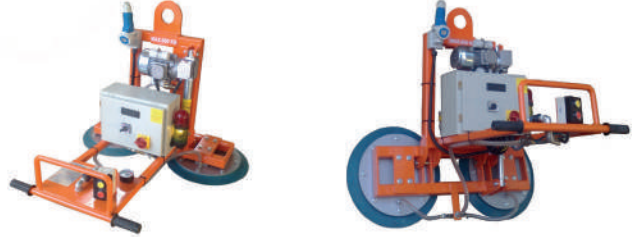

TECHNICAL SPECIFICATIONS

MODEL	VMP-A 500 / 2
LIFTING CAPACITY	500 KG
SYSTEM	VACUUM PUMP
TILTING	LINEER ACTUATOR
SYSTEM REQUIREMENT	ELECTRIC
MAX.WORKPIECE DIMENSIONS	1500 X 2500
MIN.WORKPIECE DIMENSIONS	500 X 1000



TECHNICAL SPECIFICATIONS

MODEL	VMP-A 500 / 6
LIFTING CAPACITY	500 KG
SYSTEM	VACUUM PUMP
TILTING	LINEER ACTUATOR
SYSTEM REQUIREMENT	ELECTRIC
MAX.WORKPIECE DIMENSIONS	2000 X 3000
MIN.WORKPIECE DIMENSIONS	600 X 1000

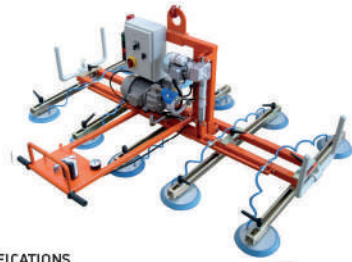

TECHNICAL SPECIFICATIONS

MODEL	VMP-A 500 / 10
LIFTING CAPACITY	500 KG
SYSTEM	VACUUM PUMP
TILTING	LINEER ACTUATOR
SYSTEM REQUIREMENT	ELECTRIC
MAX.WORKPIECE DIMENSIONS	2000 X 3000
MIN.WORKPIECE DIMENSIONS	1000 X 2000



TECHNICAL SPECIFICATIONS

MODEL	VMP-A 500 / 24
LIFTING CAPACITY	500 KG
SYSTEM	VACUUM PUMP
TILTING	LINEER ACTUATOR
SYSTEM REQUIREMENT	ELECTRIC
MAX.WORKPIECE DIMENSIONS	2000 X 3000
MIN.WORKPIECE DIMENSIONS	1500 X 2000

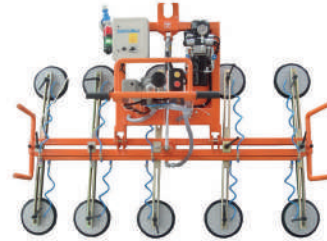

TECHNICAL SPECIFICATIONS

MODEL	VMP-A 750 / 14
LIFTING CAPACITY	750 KG
SYSTEM	VACUUM PUMP
TILTING	LINEER ACTUATOR
SYSTEM REQUIREMENT	ELECTRIC
MAX.WORKPIECE DIMENSIONS	2000 X 3000
MIN.WORKPIECE DIMENSIONS	1000 X 2000



TECHNICAL SPECIFICATIONS

MODEL	VMP-H 750 / 14
LIFTING CAPACITY	750 KG
SYSTEM	VACUUM PUMP
TILTING	HYDRAULIC
SYSTEM REQUIREMENT	ELECTRIC
MAX.WORKPIECE DIMENSIONS	2000 X 3000
MIN.WORKPIECE DIMENSIONS	1000 X 2000

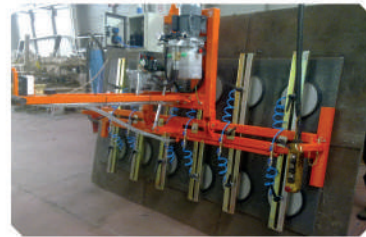

TECHNICAL SPECIFICATIONS

MODEL	VMP-H 1000 / 18
LIFTING CAPACITY	1000 KG
SYSTEM	VACUUM PUMP
TILTING	HYDRAULIC
SYSTEM REQUIREMENT	ELECTRIC
MAX.WORKPIECE DIMENSIONS	2000 X 3000
MIN.WORKPIECE DIMENSIONS	1000 X 1500

VAKUMER

250 - 500 - 700

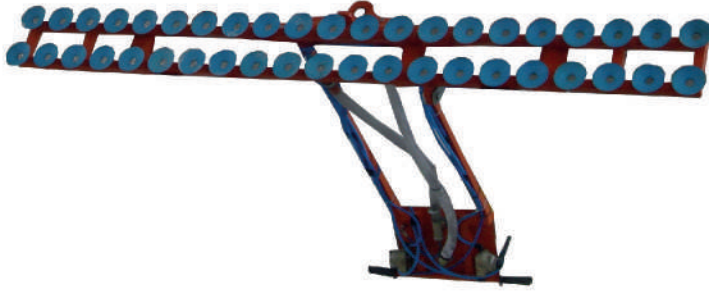

TECHNICAL SPECIFICATIONS

MODEL	VMP-D 250 / 42
LIFTING CAPACITY	250 KG
SYSTEM	VACUUM PUMP
TILTING	PNEUMATIC
SYSTEM REQUIREMENT	ELECTRIC & AIR
MAX.WORKPIECE DIMENSIONS	650 X 3000
MIN.WORKPIECE DIMENSIONS	200 X 200



TECHNICAL SPECIFICATIONS

MODEL	VMP-D 500 / 56
LIFTING CAPACITY	500 KG
SYSTEM	VACUUM PUMP
TILTING	PNEUMATIC
SYSTEM REQUIREMENT	ELECTRIC & AIR
MAX.WORKPIECE DIMENSIONS	650 X 3000
MIN.WORKPIECE DIMENSIONS	300 X 300



TECHNICAL SPECIFICATIONS

MODEL	VMJ-D 250 / 5
LIFTING CAPACITY	250 KG
SYSTEM	VACUUM EJECTOR
TILTING	PNEUMATIC
SYSTEM REQUIREMENT	AIR
MAX.WORKPIECE DIMENSIONS	650 X 3000
MIN.WORKPIECE DIMENSIONS	250 X 2000

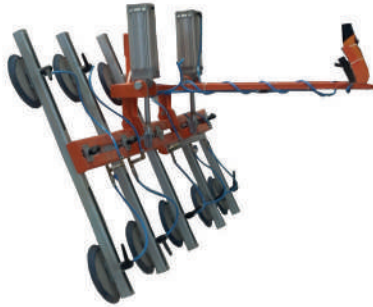

TECHNICAL SPECIFICATIONS

MODEL	VMP-D 500 / 10
LIFTING CAPACITY	500 KG
SYSTEM	VACUUM PUMP
TILTING	PNEUMATIC
SYSTEM REQUIREMENT	ELECTRIC & AIR
MAX.WORKPIECE DIMENSIONS	2000 X 3000
MIN.WORKPIECE DIMENSIONS	250 X 1000

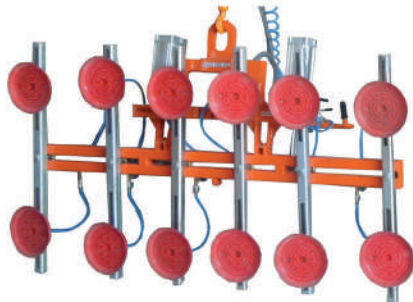

TECHNICAL SPECIFICATIONS

MODEL	VMP-D 600 / 12
LIFTING CAPACITY	600 KG
SYSTEM	VACUUM PUMP
TILTING	PNEUMATIC
SYSTEM REQUIREMENT	ELECTRIC & AIR
MAX.WORKPIECE DIMENSIONS	2000 X 3000
MIN.WORKPIECE DIMENSIONS	250 X 1000

VAKUMER

250 - 500 - 700



TECHNICAL SPECIFICATIONS

MODEL	VMP-D 750 / 18
LIFTING CAPACITY	750 KG
SYSTEM	VACUUM PUMP
TILTING	PNEUMATIC
SYSTEM REQUIREMENT	ELECTRIC & AIR
MAX.WORKPIECE DIMENSIONS	2000 X 3000
MIN.WORKPIECE DIMENSIONS	150 X 1000



TECHNICAL SPECIFICATIONS

MODEL	VMJ-D 500 / 5
LIFTING CAPACITY	500 KG
SYSTEM	VACUUM EJECTOR
TILTING	PNEUMATIC
SYSTEM REQUIREMENT	AIR
MAX.WORKPIECE DIMENSIONS	650 X 3000
MIN.WORKPIECE DIMENSIONS	250 X 2000

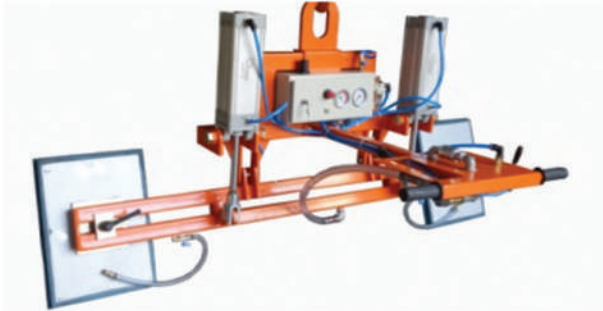

TECHNICAL SPECIFICATIONS

MODEL	VMJ-D 300 / 35X45
LIFTING CAPACITY	300 KG
SYSTEM	VACUUM EJECTOR
TILTING	PNEUMATIC
SYSTEM REQUIREMENT	AIR
MAX.WORKPIECE DIMENSIONS	1000 X 3000
MIN.WORKPIECE DIMENSIONS	350 X 450

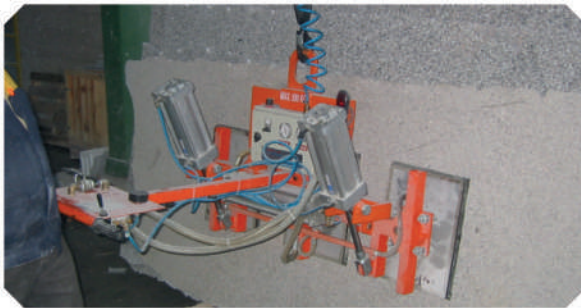

TECHNICAL SPECIFICATIONS

MODEL	VMJ-D 500 / 35X45
LIFTING CAPACITY	500 KG
SYSTEM	VACUUM EJECTOR
TILTING	PNEUMATIC
SYSTEM REQUIREMENT	AIR
MAX.WORKPIECE DIMENSIONS	1000 X 3000
MIN.WORKPIECE DIMENSIONS	350 X 450

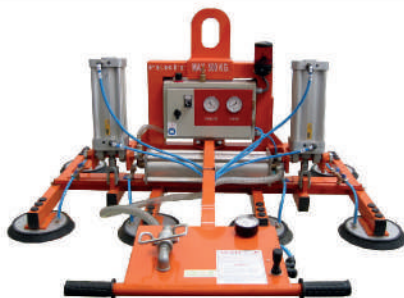

TECHNICAL SPECIFICATIONS

MODEL	VMJ-D 500 / 10
LIFTING CAPACITY	500 KG
SYSTEM	VACUUM EJECTOR
TILTING	PNEUMATIC
SYSTEM REQUIREMENT	AIR
MAX.WORKPIECE DIMENSIONS	2000 X 3000
MIN.WORKPIECE DIMENSIONS	250 X 1000

AUTOMAR STRIP

OTOMATİK STRİP YÜKLEME VE BOŞALTMA MAKİNASI

Otomatik Strip yükleme ve boşaltma makinası özellikle baş kesme, yarma makinasına, veya cila makinasına strip yükleme yada boşaltmasında kullanılır. Blok kesme makinasında kesilerek paletlere dik ya da yatay olarak dizilen stripler forklift ile otomatik yükleme makinasının önüne konur. Çalışan elemanın operator paneline taşın konumu (dik/yatık) ve yüksekliğini yazıp boşaltması yeterlidir. Otomatik strip yükleme robotu sıra ile paletten aldığı stripleri kendi motorize konveyörüne yatık vaziyette bırakır motorize konveyör hattın devamındaki (baş kesme, yarma, cila) işleme makinasında bir önceki taşın işlemi bittiyse ikinci taşı ilerletir. Bu arada otomatik strip yükleme robotu diğer taşı getirir, eğer motorize konveyörde ürün bekliyorsa indirmeden bekletr konveyörden strip çıktığında iner ve taşı bırakır.



AUTOMATIC LOADING-UNLOADING SYSTEM FOR STRIPS

Automatic strips loading/unloading machines are used to load/unload work-pieces to marbles head cutting and marble polishing machines. The strips are placed front of the automatic loading machines by the lift which are kept horizontal/vertical position on the pallets after cutting by automatic block cutting machines. It just needs to operator enter the position and height of the strip than start up the machine. Automatic strip loading machine takes the strips from pallets in order, than put on the conveyor with in horizontal position. Conveyor automatically feed the second strip to the machine after finishing first strip. In present, automatic strip loading/unloading machine makes the other strip ready for conveyor.



AUTOMAR YR - 600-90 PLAKA CİLA YÜKLEME VE BOŞALTIMA

Mermer plaka cila hattının girişinde yükleme, çıkışında boşaltma amaçlı kullanılır. Ayrıca reçine hatlarında yükleme boşaltma amaçlı kullanılır. Yükleme ve/veya boşaltma işlemini tam otomatik olarak gerçekleştirir. Her çeşit mermer veya granit plakanın taşınması mümkün olup traverten için vakum sistemi farklı bir model üretilmiştir.

It is used for loading at the beginning of the slab polishing line and for unloading at the end of slab polishing line. Additionally, it is used for the purpose of loading and unloading in resin lines. Loading/unloading operation is executed full-automatically.

All sorts of marble and granite slabs can be lifted, but for travertines a special model with a different vacuum system was developed

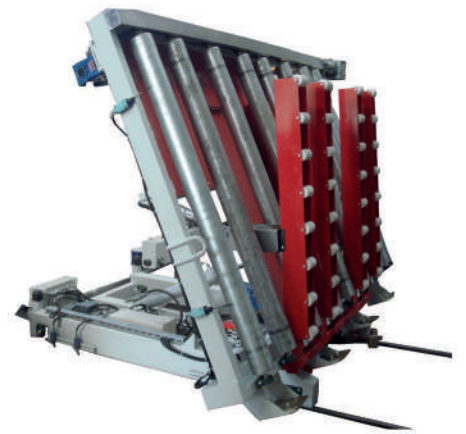

AUTOMAR AIR 600 - 180

EPOKSİ VEYA POLYESTER HATTI FIRIN YÜKLEME VE BOŞALTMA SİSTEMLERİ

Katlı fırın ve tünel fırınların yükleme boşaltma işlemini otomatik olarak yapmak için kullanılır.

Automar Air 600-180 direkler üzerinde oluşturulan yürüme yollarında köprülü kreyn gibi çalışır.

Katlı fırına katrak vagonundan direk yükleme yapabilir. Fırında önyüz işlemi yapıp geri gelen plakayı 180° ters yüz çevirip tekrar fırına verebilir. İşlemi biten plakayı alıp bitmiş ürün paletine koyar. Yani katlı fırın yükleme ve boşaltma işlemini aynı noktadan yapabilir.

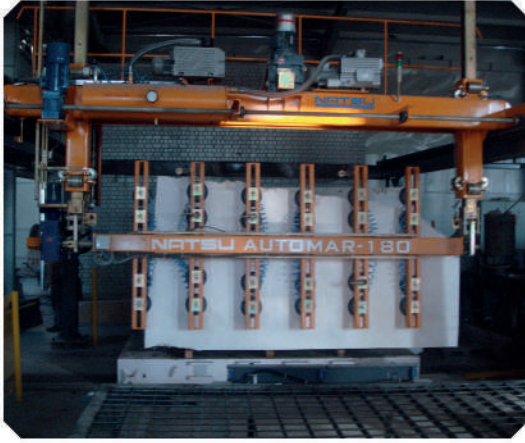

AUTOMAR STANDART MAKİNALAR

MODEL	KALDIRMA KAPASİTESİ Lifting Capacity	VAKUM SİSTEMİ Vacuum System	DÖNDÜRME SİSTEMİ Rotation System	DÖNDÜRME AÇISI (°) Rotation Angle	TAŞIYABİLECEĞİ EN BÜYÜK MERMER EBADI (mm) Max. Dimensions
AUTOMAR 600-90	600 kg.	Pompa	Hidrolik	90°	2000x3000
AUTOMAR AIR 600-180	600 kg.	Pompa	Redüktörlü Motorlu	180°	2000x3000
AUTOMAR YR 600-180	600 kg.	Pompa	Redüktörlü Motorlu	180°	2000x3000
AUTOMAR STRIP	200-300 kg.	Pompa	Pnömatik	90°	650x3000



YARMA ÇIKIŞI ÇİFT MERMER AYIRMA VE ÇEVİRME

Yatay yarma makinasından ikiye ayrılmış üst üste çıkan taşlar önce tek hale getirir birinciyi çevirmeden iletir ikinci taşı ters yüz edip bir sonraki işlem için iletir.

Bu iki parçadan oluşur.Önde bir ayırma ve arkasında çevirme.Yarma makinası çıkışında hem ayırma hem çevirme gerekirken dolgu hatlarında veya iki yönü epoksi yapılacak taşlarda bir yöndeki işlem bittiğinde diğer yüzün çevrilmesi için sadece çevirme makinası kullanılır.

Kendi PLC programı sayesinde gelen taşları sensörler yardımı ile göreyek bütün işlemleri otomatik olarak yapar. Standart tipde iki ölçü vardır;

1. Min. 300 mm - Max. 1000 mm taşlar için
2. Min. 300 mm - Max. 2000 mm taşlar için



SPLITTING-TILTING ON THE WAY OUT OF SLITING MACHINE

It arranges the splitted products in a row on the way out of the splitting machine .It conveys the first product,turns the second product upside down and delivers for the next process afterwards.

It consists of two parts: a separation unit in the front and tilting unit behind. While, both splitting and tilting is required on the way out of the splitting machine; in filling Or epoxy lines, only tilting is used to turn the product upside down after the process is finished. Through the agency of its PLC program, it executes the whole operation automatically by sensing the products with the sensors. There are two standard types;

1. Min. 300 mm - Max. 1000 mm. products
2. Min. 300 mm - Max. 2000 mm. products



NATSU ACROBAT

MONTAJ ROBOTU

NATSU ACROBAT MONTAJ ROBOTU

Şantiyelerde cam, mermer ve granit gibi plakaların cepheye, zemine veya tavana montajında kullanılan ekipmandır.

Teleskobik yükleyici veya forklift çatalına monte edilebilecek şekilde tasarlanan Natsu Acrobat montaj robotu operatör tarafından son derece hassas konumlandırma yapabilir özelliktedir.

- 500 kg kaldırma kapasitesine sahiptir.
- Çalışma yarıçapı 1810 mm'dir.
- 220V enerji bağlantısı ile çalışır. Opsiyonel olarak 24V şarj edilebilir bataryalı da imal edilebilir.
- Tüm hareketleri hidrolik tahriklidir.
- Merkezden sola 10°, merkezden sağa 10° dönüş.
- Merkezden 20° aşağı, merkezden 20° yukarı dönüş.
- Vakum kayıplarında kumanda paneli üzerinde sesli ve ışıklı ikaz.

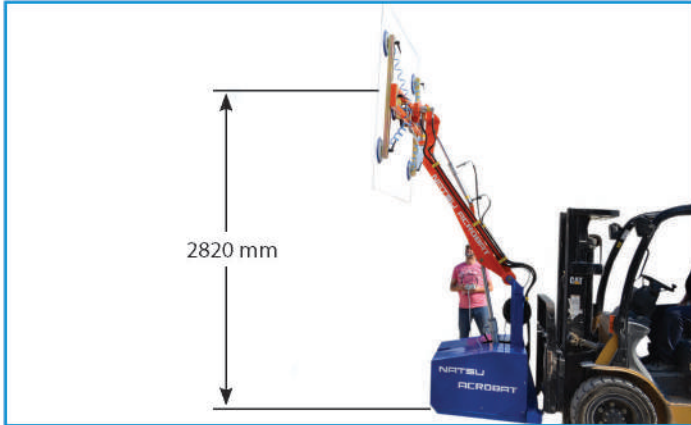
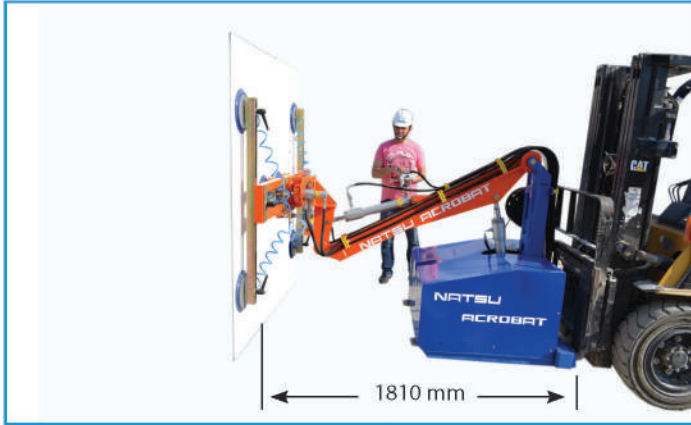

NATSU ACROBAT ASSEMBLY ROBOT

Used for mounting/assembling glass, marble and granite plates to facades, floors or ceilings of building sites.

Natsu Acrobat, designed also to be mounted onto telescopic loaders or forklift forks if necessary, allows the operator to position the loads highly accurately.

Technical Specifications:

- Lifting capacity: 500 kg
- Working radius: 1810 mm
- Works with a 220V connection. Can be manufactured with 24V rechargeable battery if requested.
- All movements are hydraulically driven.
- 10° center-to-left, 10° center-to-right rotation
- 20° center-to-down, 20° center-to-top rotation
- Vocal and luminous alarm on control panel in case of vacuum loss

PNOVAC

PNÖMATİK VAKUMLU KALDIRICI

PNOVAC

PNÖMATİK VAKUMLU KALDIRICI

İşinizi daha güvenli, daha üretken ve daha verimli hale getirin Natsu Vakum Kaldırıcıları ; kuruluşunuzun yeteneklerini genişletmeye yardımcı olan manuel iş süreçleri için eksiksiz bir ergonomik taşıma teknolojileri paketi sunar.

Temel iş alanlarımız arasında olan mermer ve cam endüstrisi için NATSU Vakumlu kaldırıcıları, mermer atölyelerinde mutfak tezgah plakalarının imalatında, cam atölyelerinde pencere montaj hatları ile cam istasyonları arasında taşıma kaldırma ve çevirme işleri için geliştirilmiştir.

Güç gereksinimi olarak sadece basınçlı hava ihtiyacı olan PNOVAC farklı ölçülerdeki ürünleri vakumla tutabilmek için x ve y eksenlerinde kolayca hareket ettirilebilen vakum vantuzlarına sahiptir. Son derece ergonomik yapıya sahip olan PNOVAC kullanan elemana ek bir yük getirmez. Yere yakın zeminden urun alırken tutma kolu ayakta dikilme mesafesinde kalmaya devam eder.

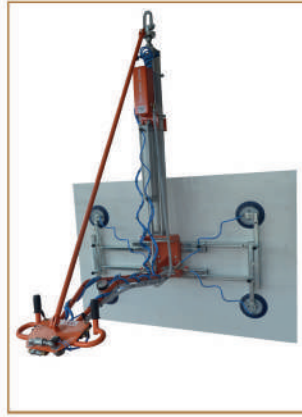

PNOVAC

PNEUMATIC VACUUM LIFTER

Make your job safer, productive and efficient. Natsu vacuum lifters; provide you with absolute ergonomic delivery technologies for manual job periods which help your company's talents to increase.

NATSU Vacuum Lifters produced for our main jobs such as marble and glass industries are there for you to use in marble factories, kitchen construction, glass factories, window assembling by moving, lifting, rotating etc.

PNOVAC requiring pressured air only to work has vacuum sucking discs that can be moved in x and y axis easily to hold various-sized objects. PNOVAC has such an ergonomic structure that it is not burdensome for the worker. The handle stays on hand level when grabbing an object from the ground level.

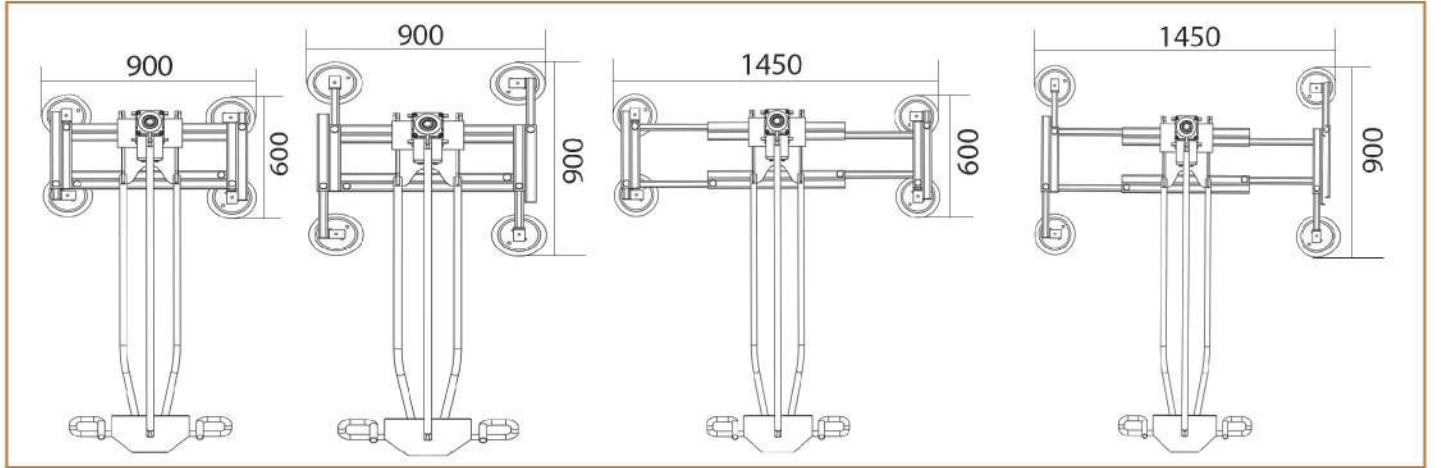

- 90 derece öne doğru eğme -çevirme yapılabilir
- Elektrik gerekmez; hem kaldırma, hem vakum için sadece hava kullanılır.
- Eğme - çevirme hızları ayarlanabilir.
- İki renkli vakum göstergesi (yeşil-kırmızı)
- Vakum azalmalarında kullanıcıyı uyarıcı sesli ve ışıklı uyarı.
- 200 kg 'a kadar kaldırma kapasitesi
- 1200 mm'ye kadar kaldırma yüksekliği
- Kolay ayarlanabilir ve değiştirilebilir vakum vantuzları
- Her türlü malzemeye göre uygun vakumlu vantuz tutucuları.(yağlı-ıslak-sıcak)
- Mükemmel son ürün kalitesi - çizik yok
- İnce kırılabilir ve büyük camların,mermerlerin taşınabilmesi
- İşgücü maliyetinden tasarruf.

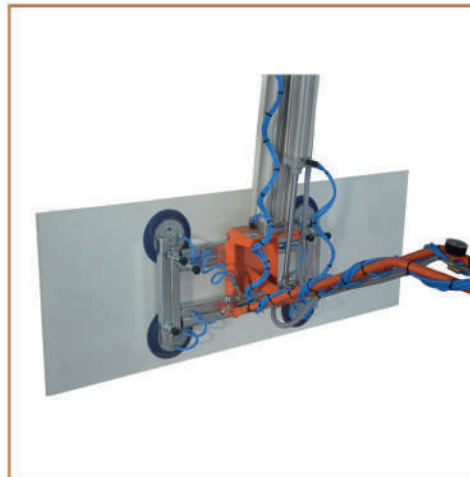

- 90 degree tilt and rotate
- No need for electricity; only air for vacuum and lifting
- Tilting and rotating speed adjustable
- Green and red vacuum indicator
- Light and voiced warning on vacuum decrease
- Up to 200 kg lift capacity
- Up to 1200 mm lift height
- Adjustable and alterable vacuum sucking discs
- Vacuum sucking discs suitable for all kind of objects (oily, wet, hot etc.)
- Perfect product quality, no scratch
- Can carry thin vulnerable and large glasses
- Saving at manpower cost